

FIG. 1

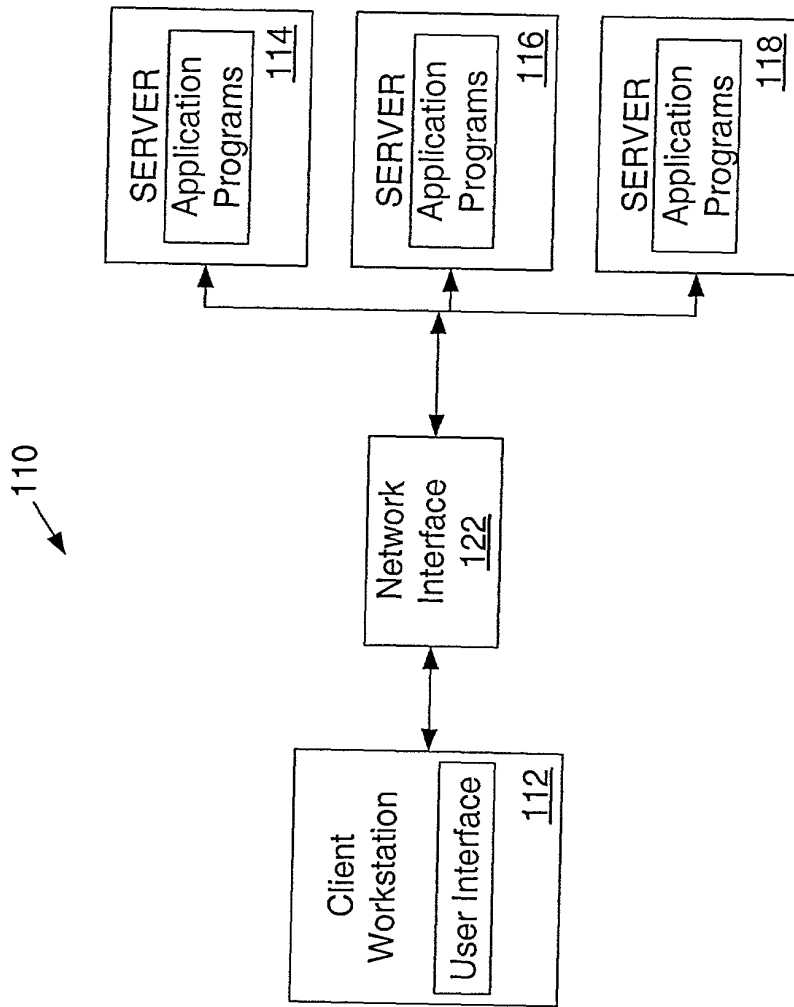

Fig. 1

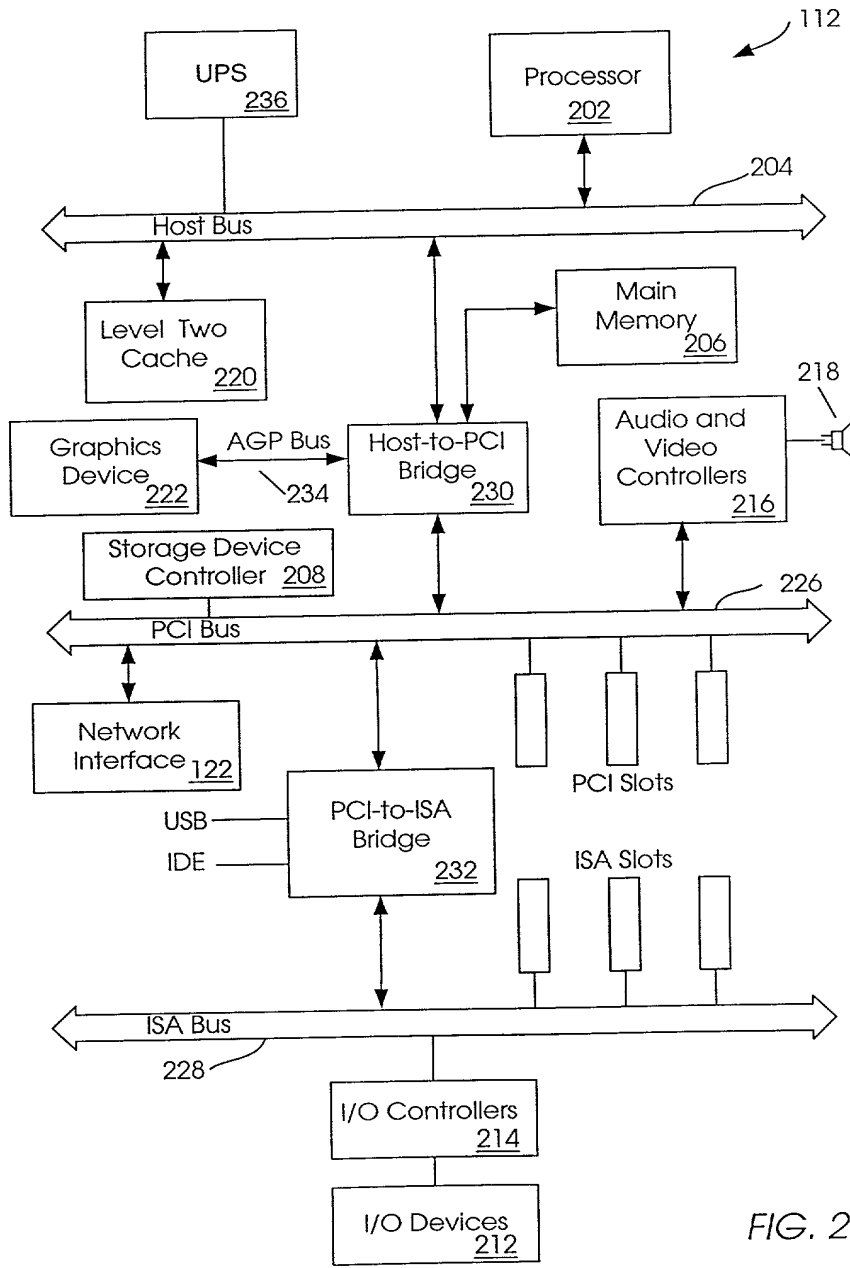

FIG. 2

FIG. 2

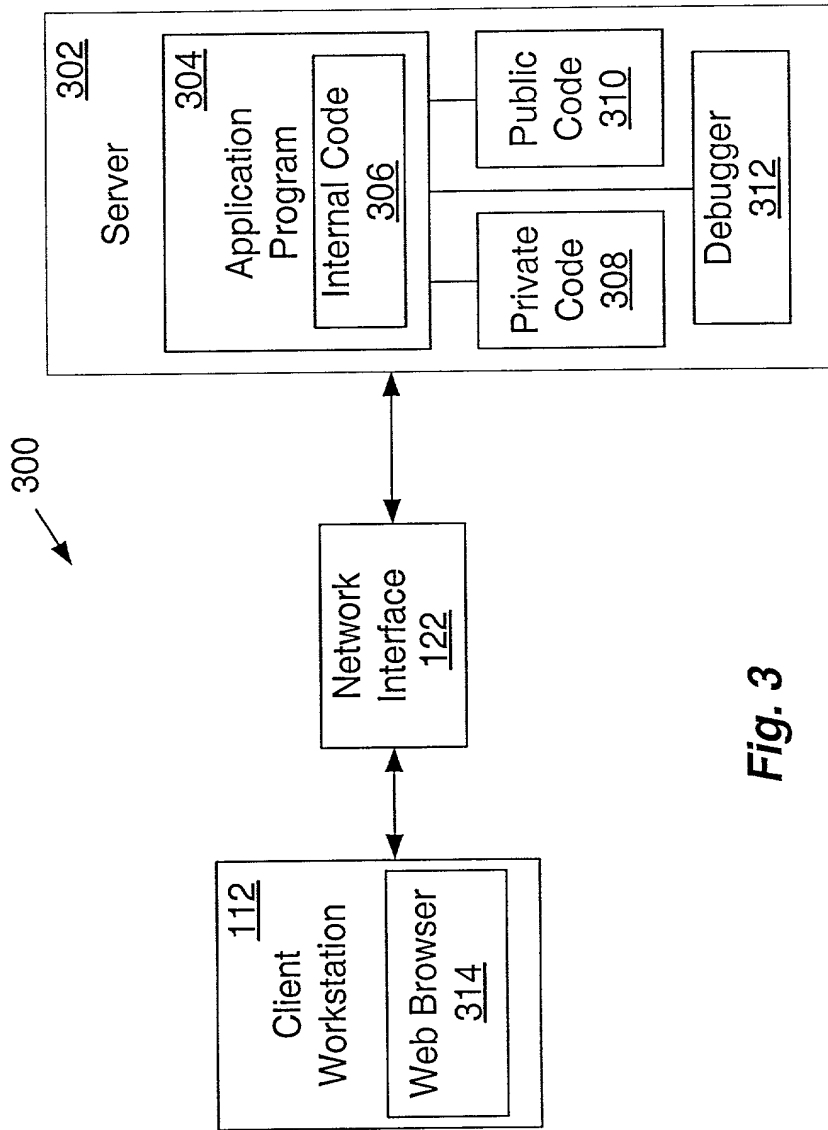

Fig. 3

FIG. 3

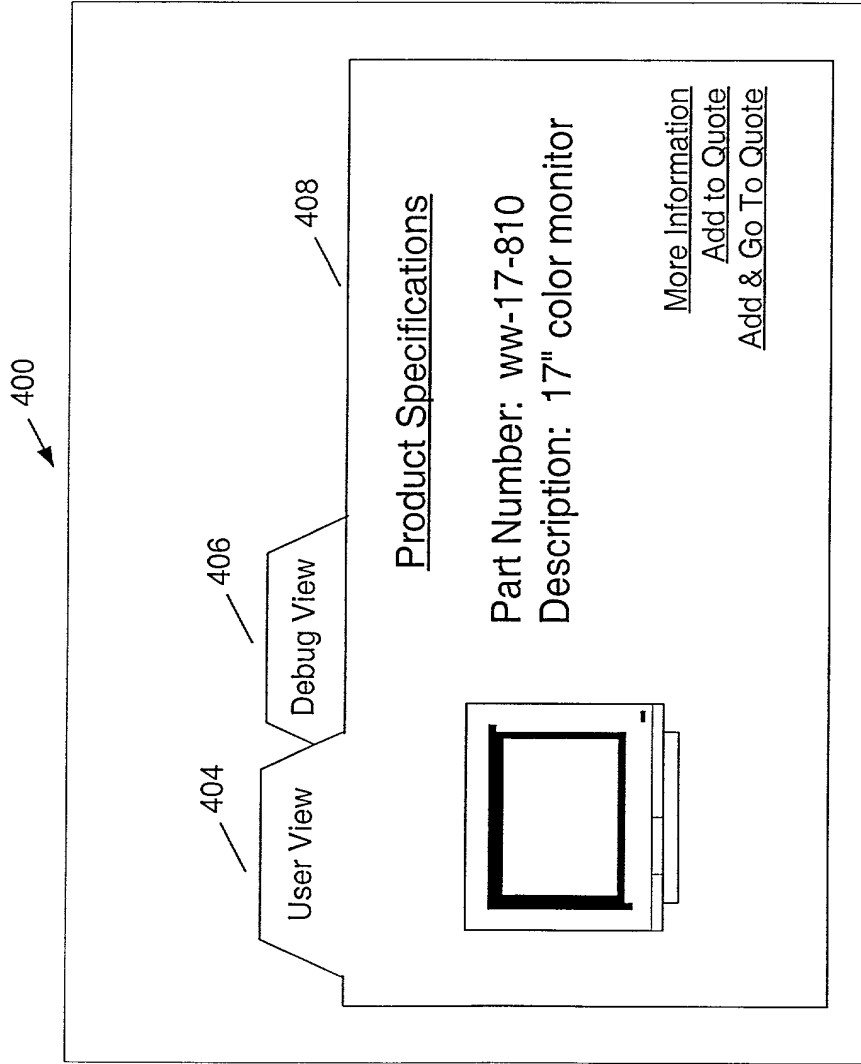

Fig. 4a

FIG. 4b

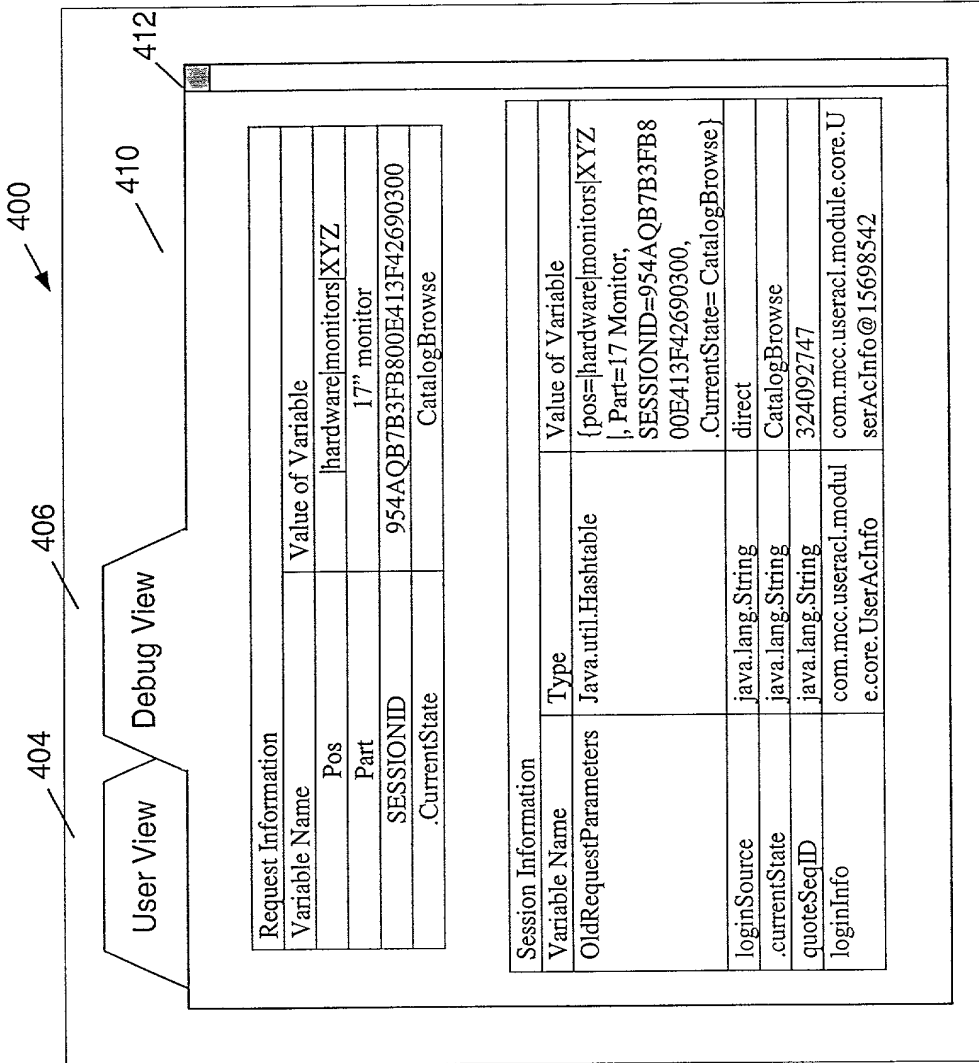

Fig. 4b

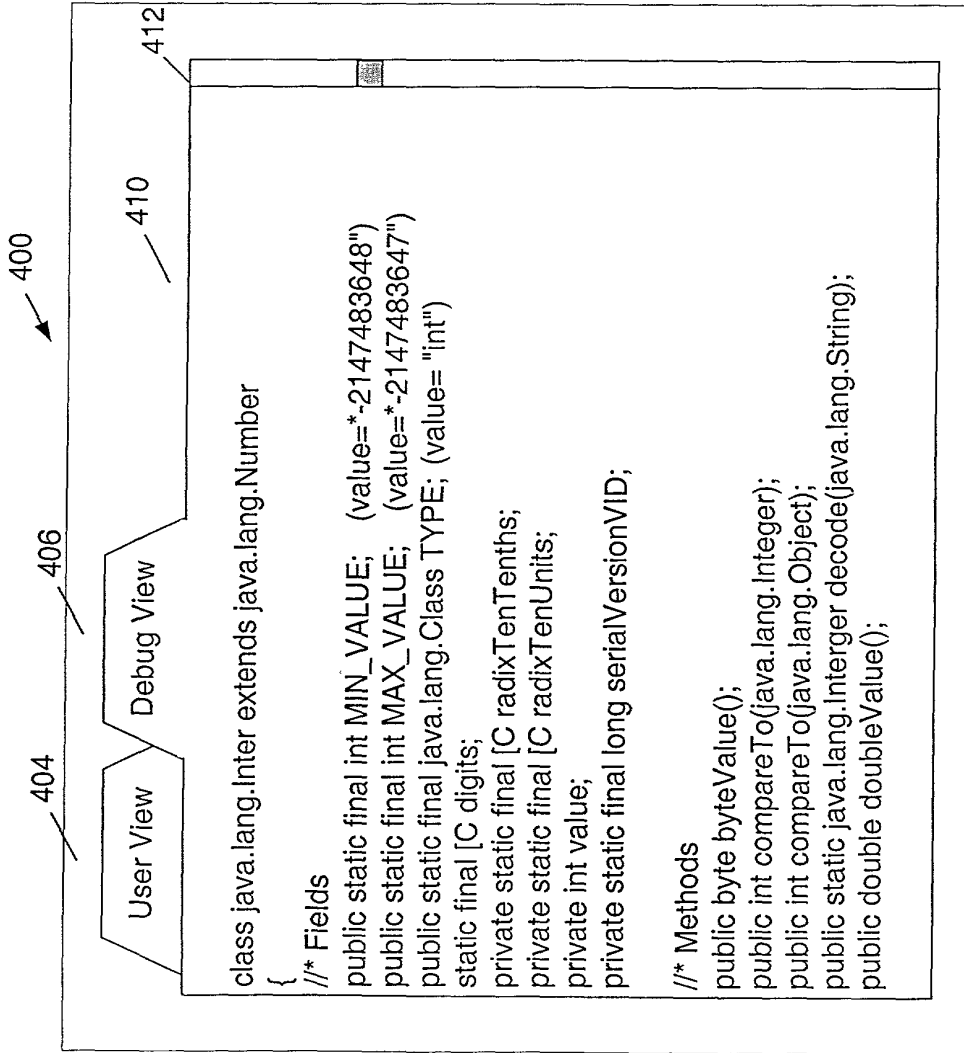

Fig. 4c

FOOT 20" 82720650

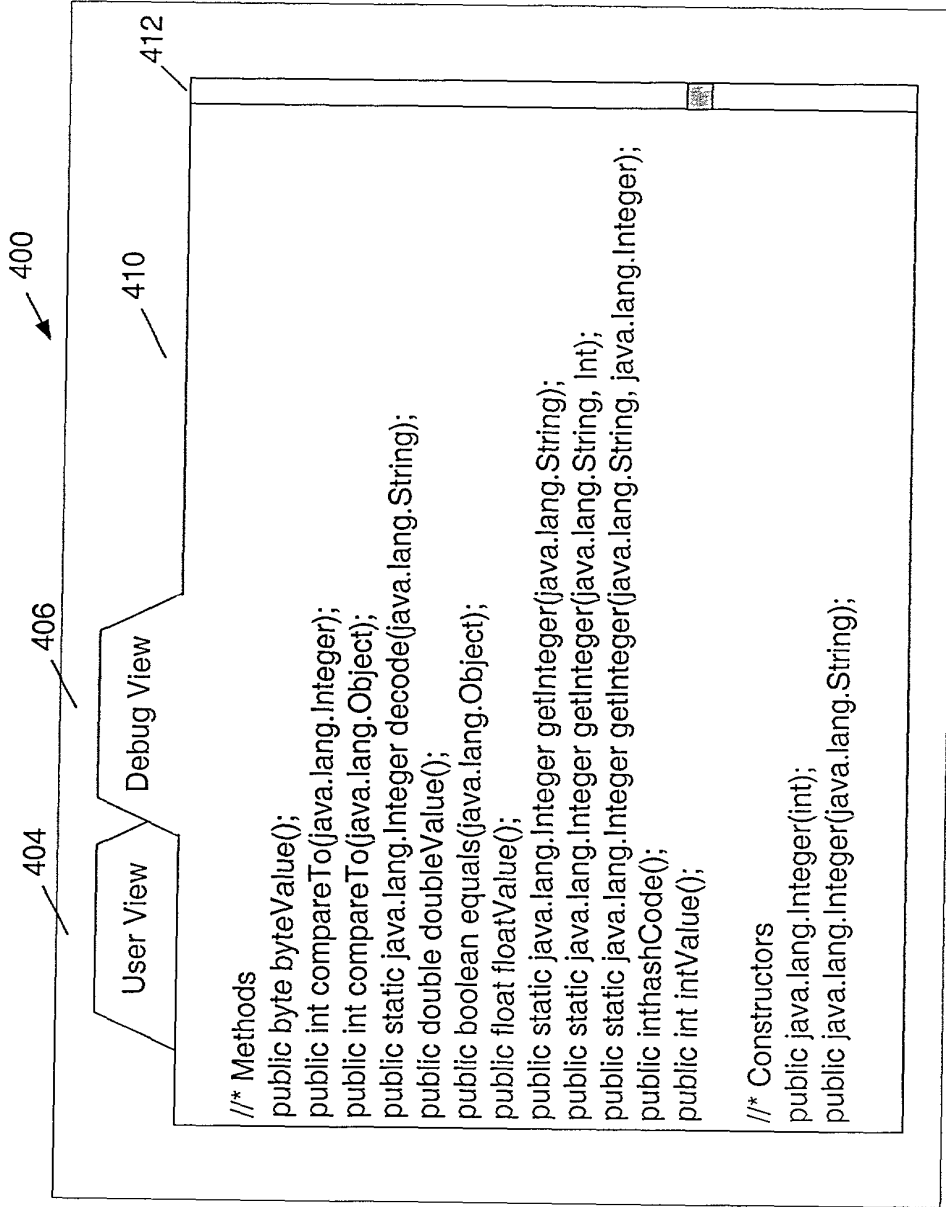

Fig. 4d

FIG. 40

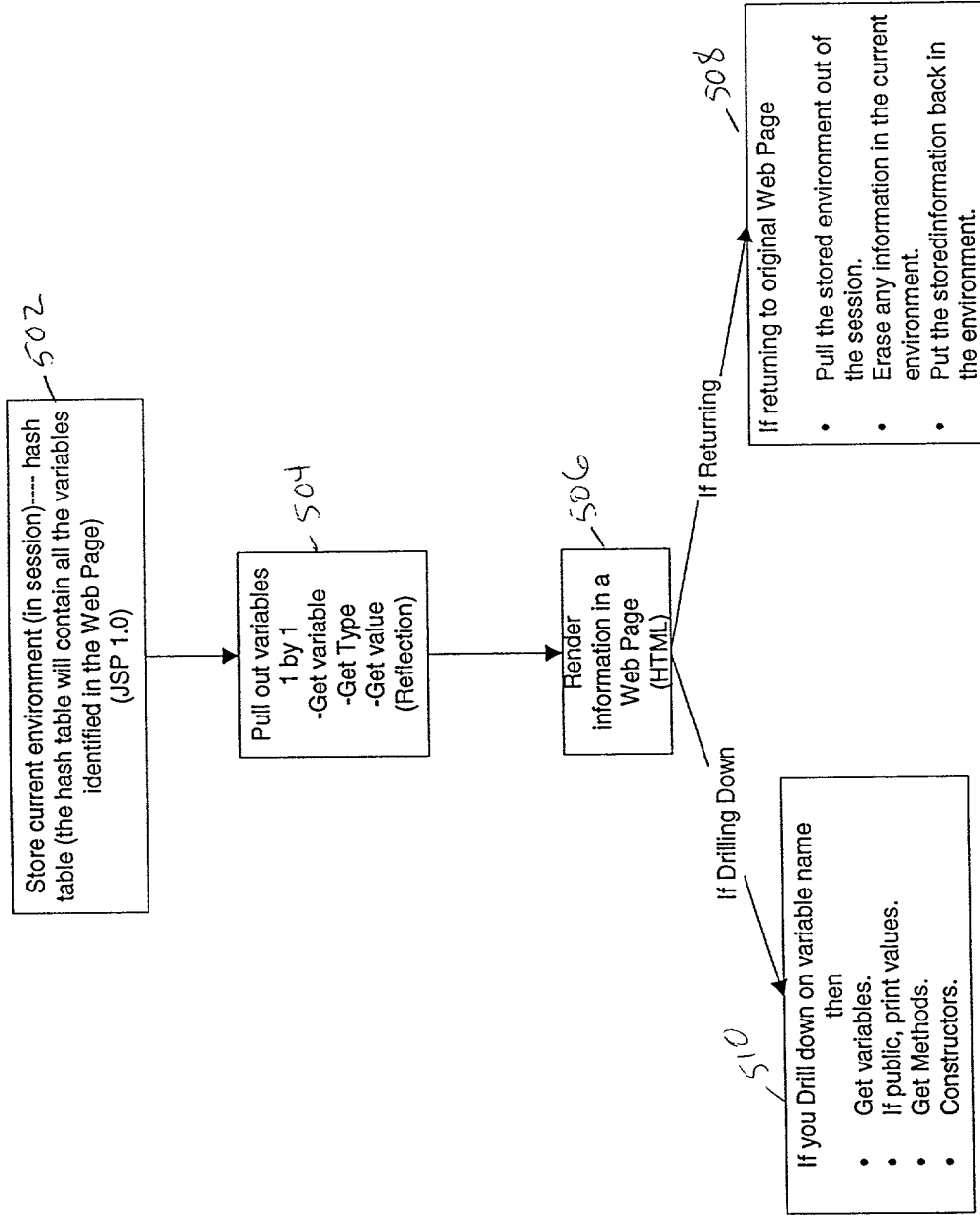

Figure 5